

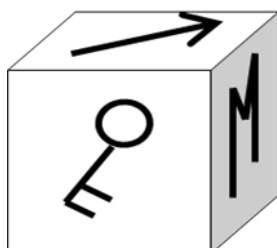

Uzupełnij rysunek tak, aby otrzymać siatkę poniższego sześcianu. Sprawdź odpowiedź. Jeśli rozwiążesz poprawnie dwa kolejne przykłady z jednego poziomu, możesz przejść na następny poziom.

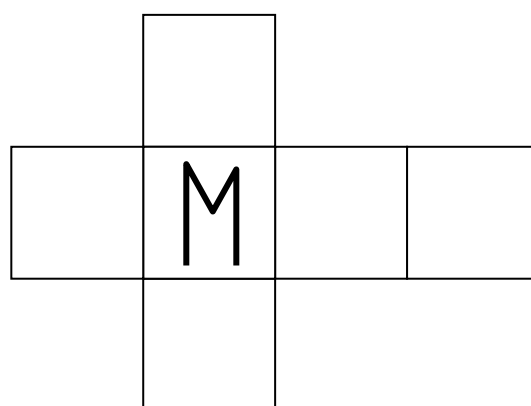

poziom A

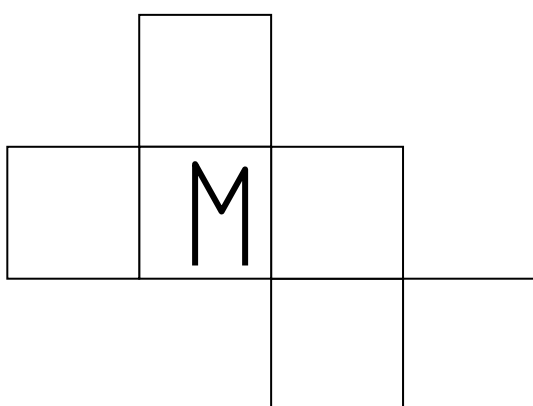
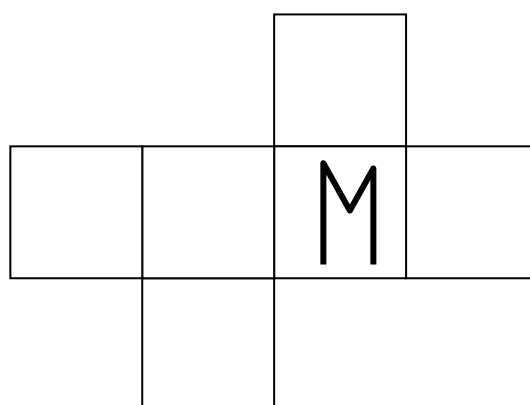
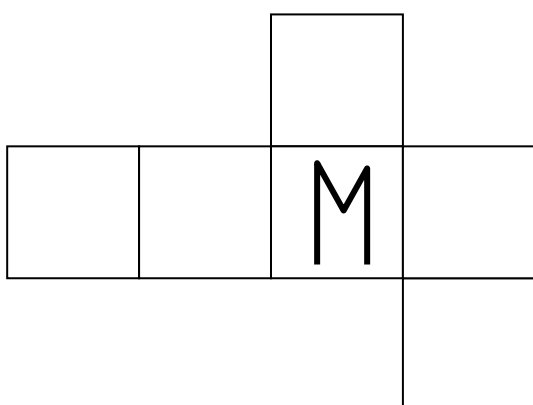

poziom B

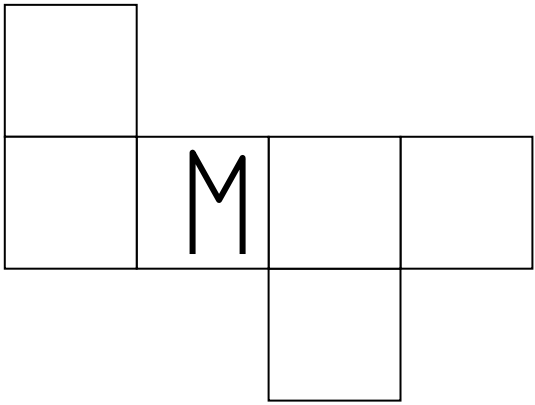
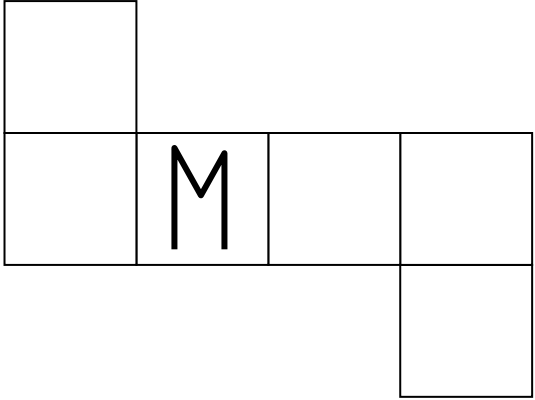
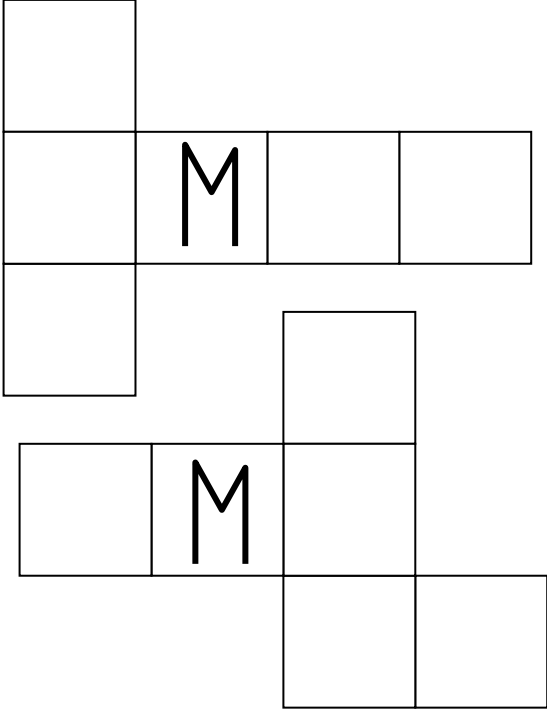

poziom C

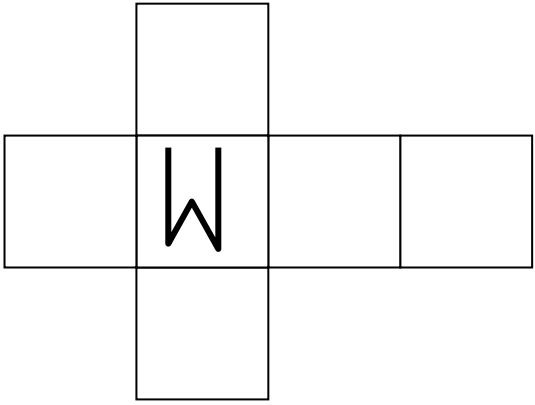
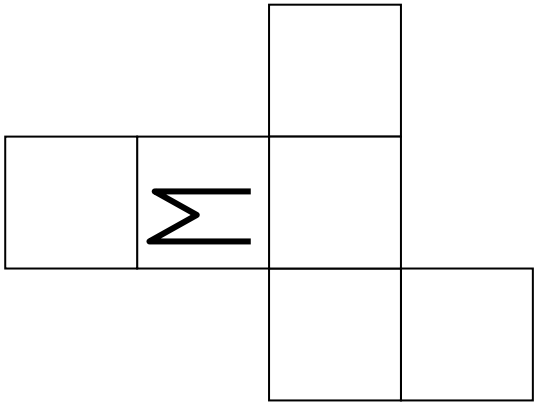
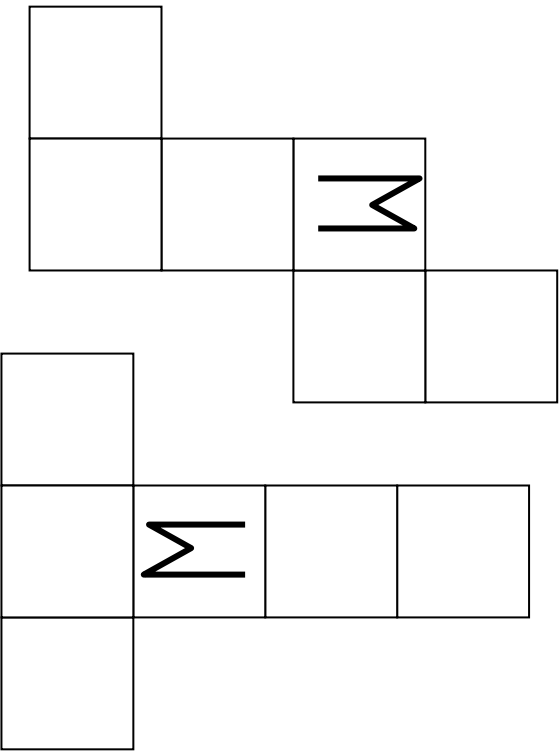

poziom D

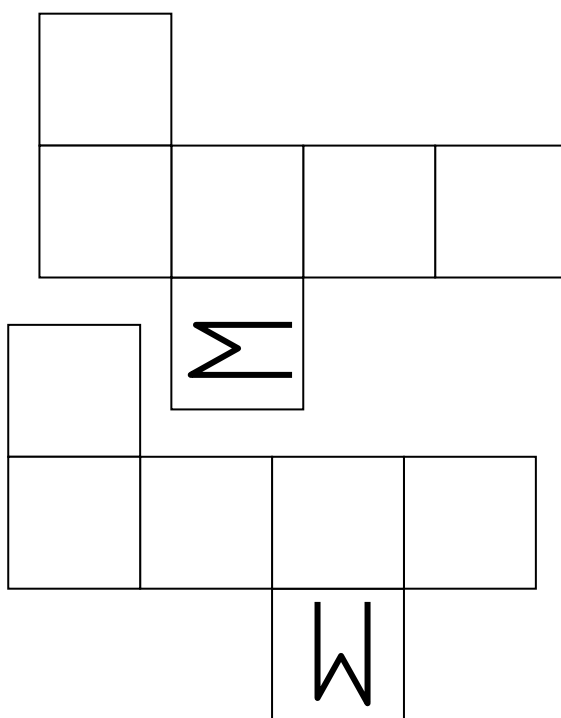
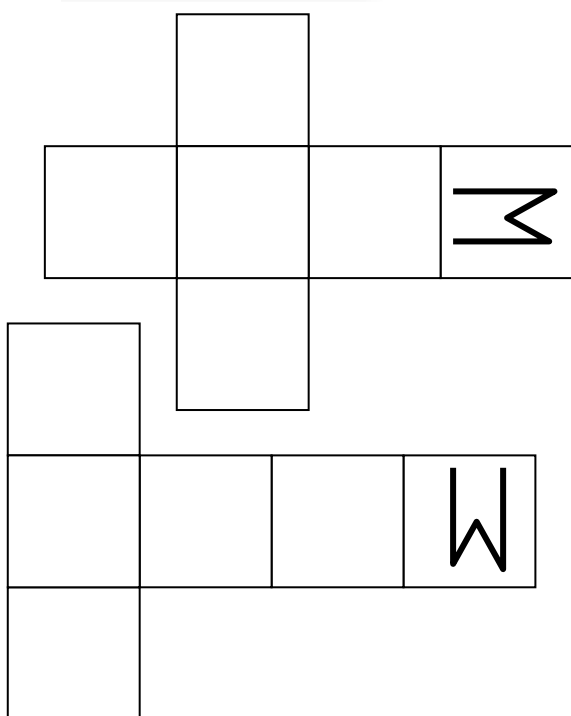

poziom E

